

FILE: J:\CUSTDWG\DCA\DCA004004

INDUCTANCE	LOSSES	WEIGHT
2.5 mH	29 Watts	21 Lbs

NO.	CHANGE DESCRIPTION	BY	DATE	C'K'D
-----	--------------------	----	------	-------

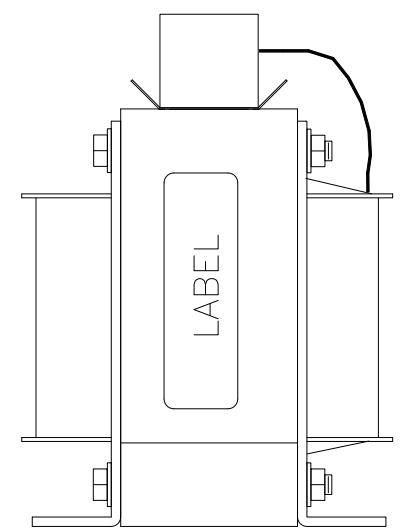
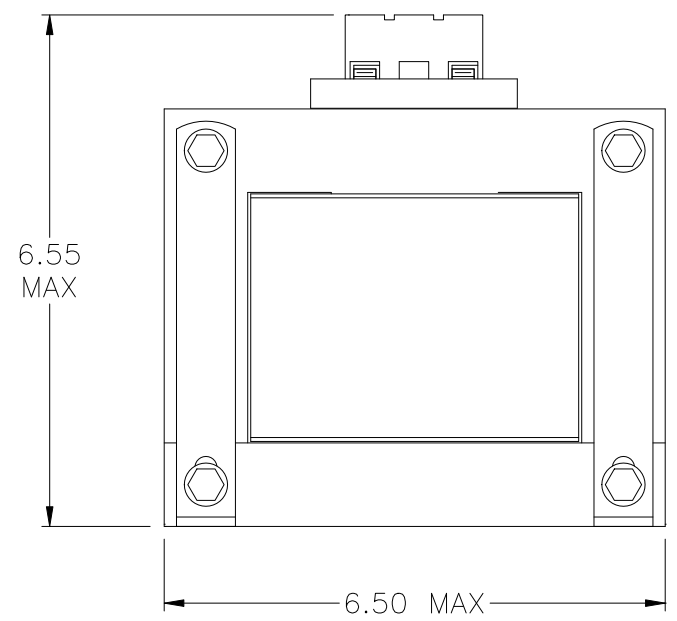
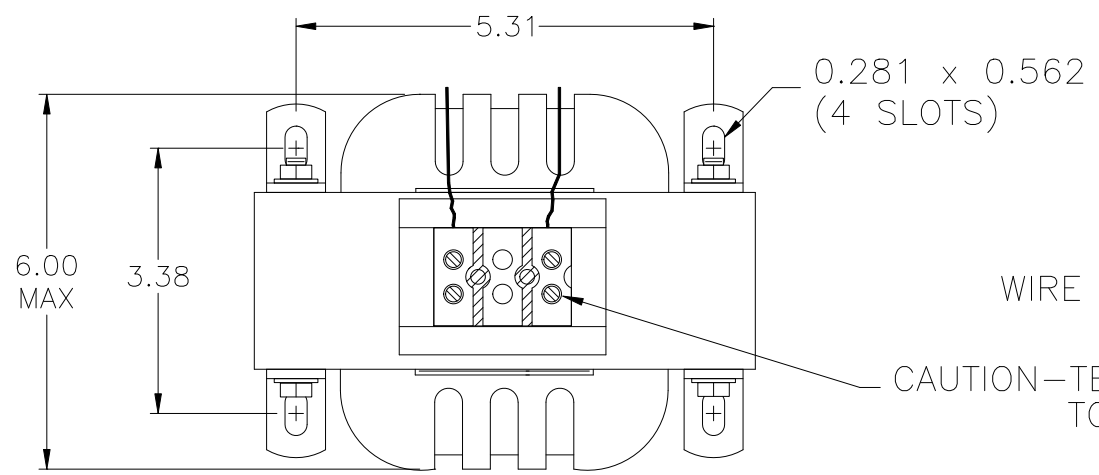

UNLESS OTHERWISE SPECIFIED, DIMENSIONS ARE IN INCHES [mm] AND TOLERANCES ARE:

DECI.	FRAC.
ANGLES	DRILLED HOLES

PART NAME:	DC CHOKE
DESCRIPTION:	OUTLINE DIMENSION
FINISH:	

MTE CORPORATION MENOMONEE FALLS, WISCONSIN		
DCA004004		REV. 00
SCALE NTS	DATE 06/28/05	C'K'D
REF.	DR. BY AGK	APP'D